

## DS-2TD1217-3/QA Thermographic Network Turret Camera



Hikvision DS-2TD1217-3/QA Thermographic Network Turret Camera can be applied to substations, hydropower stations, waste incineration plants, manufacturing workshops, etc. The accurate temperature measurement device sends temperature exception alarms for loss prevention.

- 160 × 120 resolution, 17 μm, VOx UFPA, NETD < 40 mK (25 °C, F# = 1.1)
- High accuracy temperature exception alarm, -20 °C to 150 °C (-4 °F to 302 °F) ± 8 °C (±14.4 °F)
- Image processing technology: linear, histogram, self-adaptive thermal AGC mode, DDE, 3D DNR



## ▪ Detection Range Table

Detection Range (Vehicles: 1.4 × 4.0 m)	Detection Range (Humans: 1.8 × 0.5 m)	Recognition Range (Vehicles: 1.4 × 4.0 m)	Recognition Range (Humans: 1.8 × 0.5 m)	Identification Range (Vehicles: 1.4 × 4.0 m)	Identification Range (Humans: 1.8 × 0.5 m)
280 m	91m	70 m	23 m	35 m	11 m

## ▪ DORI

VCA Range (Vehicles: 1.4 × 4.0 m)	VCA Range (Humans: 1.8 × 0.5 m)	Temperature Measurement (Object: 2 × 2 m)	Temperature Measurement (Object: 1 × 1 m)
43 m	15 m	66 m	33 m

## ▪ Specification

Thermal Module	
Image Sensor	Vanadium Oxide Uncooled Focal Plane Arrays
Resolution	160 × 120
Pixel Pitch	17 μm
Spectral Range	8 μm to 14 μm
NETD	< 40 mK (@ 25 °C, F# = 1.1)
Focal Length	3.1 mm
IFOV	5.48 mrad
Field of View	50.0° × 37.2° (H × V)
Min. Focusing Distance	0.2 m
Aperture	F1.1
Digital Zoom	× 2, × 4
Optical Module	
Image Sensor	1/2.7" Progressive Scan CMOS
Resolution	2688 × 1520
Min. Illumination	Color: 0.0176 Lux @ (F2.25, AGC ON), B/W: 0.0035 Lux @ (F2.25, AGC ON)
Shutter Speed	1 s to 1/100,000 s
Focal Length	4 mm
Field of View	84.0° × 44.8° (H × V)
Aperture (Range)	F2.3
WDR	120 dB
Image Effect	
Target Coloration	Yes. Supported in white hot and black hot mode.
Illuminator	
IR Distance	Up to 15 m
IR Intensity and Angle	Automatically adjusted
Audible and Visual Alarm	
White Light Range	Up to 30 m

Visual Alarm	Yes. White light alarm with adjustable flashing frequencies
Audio alarm	Yes, for two types of audible alarm (VCA, Temperature) 2 preset voice alerts (one for each) 6 importable user-defined voice alerts (4 options shared in the two types)
<b>Smart Function</b>	
VCA	4 VCA rule types (line crossing, intrusion, region entrance, and region exiting), up to 8 VCA rules in total.
Temperature Measurement	3 temperature measurement rule types, 21 rules in total (10 points, 10 areas, and 1 line)
Temperature Range	- 20 °C to 150 °C (- 4 °F to 302 °F)
Temperature Accuracy	± 8 °C (± 14.4 °F)
<b>Video and Audio</b>	
Main Stream	Thermal: 25 fps (1280 × 720, 704 × 576, 640 × 480, 352 × 288, 320 × 240) Optical: 50 Hz: 25 fps (2688 × 1520, 1920 × 1080, 1280 × 720) 60Hz: 30 fps (2688 × 1520, 1920 × 1080, 1280 × 720)
Sub-stream	Thermal: 25 fps (704 × 576, 352 × 288, 320 × 240) Optical: 50 Hz: 25 fps (704 × 576, 352 × 288) 60 Hz: 30 fps (704 × 480, 352 × 240)
Video Compression	Main Stream: H.265/H.264 Sub-Stream: H.265/H.264/MJPEG
Audio Compression	G.722.1/G.711ulaw/G.711alaw/MP2L2/G.726/PCM
<b>Network</b>	
Protocols	IPv4/IPv6, HTTP, HTTPS, 802.1x, QoS, FTP, SMTP, UPnP, SNMP, DNS, DDNS, NTP, RTSP, RTCP, RTP, TCP, UDP, IGMP, ICMP, DHCP, PPPoE
Network Storage	MicroSD/SDHC/SDXC card (up to 256 G) local storage, NAS (NFS, SMB/CIFS), Auto Network Replenishment (ANR)
API	ISAPI, HIKVISION SDK, third-party management platform,
Simultaneous Live View	Up to 20 channels
User/Host level	Up to 32 users, 3 levels: Administrator, Operator, User
Security	User authentication (ID and PW), MAC address binding, HTTPS encryption, IEEE 802.1x(EAP-MD5, EAP-TLS), access control, IP address filtering
Client	iVMS-4200, Hik-Connect
Web Browser	Live view (plug-in allowed) : Internet Explorer 11 Live view (plug-in free) : Chrome 57.0 +, Firefox 52.0 + Local service : Chrome 57.0 +, Firefox 52.0 +
<b>Interface</b>	
Alarm Input	1, alarm input (0-5 VDC)

Alarm Output	1, alarm output (alarm response actions configurable)
Alarm Action	SD recording/Relay output/Smart capture/FTP upload/Email linkage
Audio Input	1, 3.5 mm Mic in/Line in interface Line input: 2 - 2.4 V [p-p], output impedance: 1 K $\Omega$ $\pm$ 10%
Audio Output	Linear level, impedance: 600 $\Omega$
Communication Interface	1, RJ45 10 M/100 M Self-adaptive Ethernet interface. 1, RS-485 interface (half duplex)
<b>General</b>	
Web Client Language	32 languages English, Russian, Estonian, Bulgarian, Hungarian, Greek, German, Italian, Czech, Slovak, French, Polish, Dutch, Portuguese, Spanish, Romanian, Danish, Swedish, Norwegian, Finnish, Croatian, Slovenian, Serbian, Turkish, Korean, Traditional Chinese, Thai, Vietnamese, Japanese, Latvian, Lithuanian, Portuguese (Brazil)
Power Supply	12 VDC $\pm$ 25%, $\phi$ 5.5 mm coaxial power plug PoE (802.3af, class 3)
Power Consumption	12 VDC $\pm$ 25%: 0.5 A, Max 6 W PoE (802.3af, class 3): 42.5 V to 57 V, 0.14 A to 0.22 A, Max 6.5 W
Working Temperature/Humidity	Temperature: - 40 $^{\circ}$ C to 65 $^{\circ}$ C (- 40 $^{\circ}$ F to 149 $^{\circ}$ F) Humidity: 95% or less
Protection Level	IP66 Standard TVS 6000V lightning protection, surge protection, voltage transient protection
Dimensions	138.3 mm $\times$ 138.3 mm $\times$ 123.1 mm (5.45" $\times$ 5.45" $\times$ 4.85 ")
Weight	940 g (2.07 lb)

### ▪ Available Model



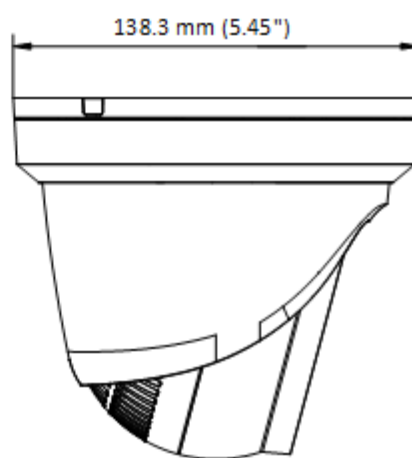
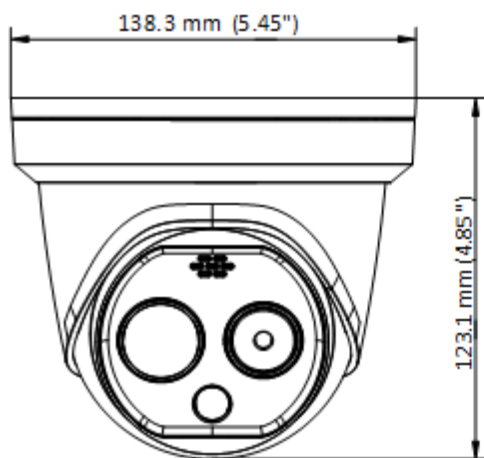

DS-2TD1217-3/QA(海外中性),DS-2TD1217-3/QA(海外标配),





### ▪ Dimension

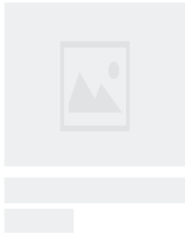
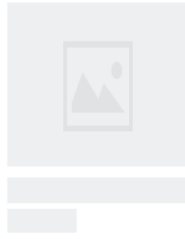
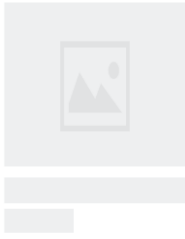
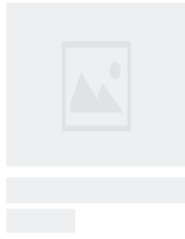
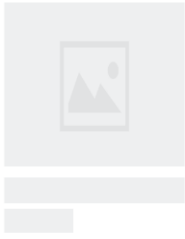

▪ **Accessory**

▪ **Optional**

DS-1276ZJ-SUS Corner mount	DS-1273ZJ-140(B LACK)	DS-1275ZJ-SUS Vertical pole mount	DS-1280ZJ-DM21 Junction box	DS-1273ZJ-140B Wall mount
				
				

<b>DS-1273ZJ-140</b> <b>Wall mount</b>	<b>DS-1271ZJ-140</b> <b>Pendant Mount</b>
	
	

Distributed by

**HIKVISION®****Headquarters**

No.555 Qianmo Road, Binjiang District,  
Hangzhou 310051, China  
T +86-571-8807-5998  
overseasbusiness@hikvision.com

**Hikvision USA**  
T +1-909-895-0400  
sales.usa@hikvision.com

**Hikvision Australia**  
T +61-2-8599-4233  
salesau@hikvision.com

**Hikvision India**  
T +91-22-28469900  
sales@pramahikvision.com

**Hikvision Canada**  
T +1-866-200-6690  
sales.canada@hikvision.com

**Hikvision Thailand**  
T +662-275-9949  
sales.thailand@hikvision.com

**Hikvision Europe**  
T +31-23-5542770  
sales.eu@hikvision.com

**Hikvision Italy**  
T +39-0438-6902  
info.it@hikvision.com

**Hikvision Brazil**  
T +55 11 3318-0050  
Latam.support@hikvision.com

**Hikvision Turkey**  
T +90 (216)521 7070- 7074  
sales.tr@hikvision.com

**Hikvision Malaysia**  
T +601-7652-2413  
sales.my@hikvision.com

**Hikvision UK & Ireland**  
T +01628-902140  
sales.uk@hikvision.com

**Hikvision South Africa**  
Tel: +27 (10) 0351172  
sale.africa@hikvision.com

**Hikvision France**  
T +33(0)1-85-330-450  
info.fr@hikvision.com

**Hikvision Kazakhstan**  
T +7-727-9730667  
nikia.panfilov@hikvision.ru

**Hikvision Vietnam**  
T +84-974270888  
sales.vt@hikvision.com

**Hikvision UAE**  
T +971-4-4432090  
salesme@hikvision.com

**Hikvision Singapore**  
T +65-6684-4718  
sg@hikvision.com

**Hikvision Spain**  
T +34-91-737-16-55  
info.es@hikvision.com

**Hikvision Tashkent**  
T +99-87-1238-9438  
uzb@hikvision.ru

**Hikvision Hong Kong**  
T +852-2151-1761  
info.hk@hikvision.com

**Hikvision Russia**  
T +7-495-669-67-99  
saleru@hikvision.com

**Hikvision Korea**  
T +82-(0)31-731-8817  
sales.korea@hikvision.com

**Hikvision Poland**  
T +48-22-460-01-50  
info.pl@hikvision.com

**Hikvision Indonesia**  
T +62-21-2933759  
Sales.Indonesia@hikvision.com

**Hikvision Colombia**  
sales.colombia@hikvision.com