

## DS-2CD2125FHWD-I(S) 2 MP Ultra-Low Light Network Dome Camera



### Key Features

- Up to 2.0 megapixel high resolution
- Max. 1920 × 1080 @60fps
- 2.8 mm/4 mm/6 mm/8 mm/12 mm fixed lens, optional
- Ultra-low light
- H.265, H.265+, H.264+, H.264
- 120dB Wide Dynamic Range
- 3D Digital Noise Reduction
- 12 VDC & PoE (802.3af)
- IR range: up to 30 m
- Support on-board storage, up to 128 GB
- Audio I/O, Alarm I/O, optional
- IP67, IK10
- 3-axis adjustment



## Specification

<b>Camera</b>	
Image Sensor	1/2.8" Progressive Scan CMOS
Min. Illumination	Color: 0.005 lux @(F1.2, AGC ON), 0 lux with IR
Shutter Speed	1/3 s to 1/100,000 s
Slow Shutter	Support
Lens	2.8 mm, horizontal field of view: 108° 4 mm, horizontal field of view: 86.4° 6 mm, horizontal field of view: 52° 8 mm, horizontal field of view: 40° 12 mm, horizontal field of view: 25°
Lens Mount	M12
Iris	F1.6
Day & Night	IR cut filter
DNR	3D DNR
Wide Dynamic Range	120dB
3-Axis Adjustment	Pan: 0° to 355°, tilt: 0° to 75°, rotate: 0° to 355°
<b>Compression Standard</b>	
Video Compression	Main stream: H.265/H.264 Sub stream: H.265/H.264/MJPEG Third stream: H.265/H.264
H.264 Type	Main Profile/High Profile
H.264+	Support
H.265 Type	Main Profile
H.265+	Support
Video Bit Rate	32 Kbps to 16 Mbps
Audio Compression (-S)	G.711/G.722.1/G.726/MP2L2
Audio Bit Rate (-S)	64Kbps(G.711)/16Kbps(G.722.1)/16Kbps(G.726)/32-128Kbps(MP2L2)
<b>Image</b>	
Max. Resolution	1920 × 1080
Main Stream	50Hz: 50fps (1920 × 1080, 1280 × 960, 1280×720) 60Hz: 60fps (1920 × 1080, 1280 × 960, 1280×720)
Sub Stream	50Hz: 25fps (640 × 360, 352 × 288) 60Hz: 30fps (640 × 360, 352 × 240)
Third Stream	50Hz: 25fps (1280×720, 640 × 360, 352 × 288) 60Hz: 30fps (1280×720, 640 × 360, 352 × 240)
Image Enhancement	BLC/3D DNR
Image Settings	Support rotate mode. Brightness, contrast, saturation, and sharpness are adjustable via web browser and client software
ROI (Region of Interest)	Support 1 fixed region for mainstream and sub stream separately
Day/Night Switch	Auto/Scheduled/Alarm Triggered (-S)
<b>Audio (-S)</b>	
Environment Noise Filtering	Support
Audio I/O	Support, mono soundtrack
Sampling Rate	16 kHz

<b>Network</b>	
Network Storage	Support microSD/SDHC/SDXC card (128G) local storage, NAS (NFS,SMB/CIFS), ANR
Alarm Trigger	Motion Detection, Tampering Alarm, Network Disconnected, IP Address Conflict, Illegal Login, HDD full, HDD error
Protocols	TCP/IP, UDP, ICMP, HTTP, HTTPS, FTP, DHCP, DNS, DDNS, RTP, RTSP, RTCP, PPPoE, NTP, UPnP, SMTP, SNMP, IGMP, 802.1X, QoS, IPv6
Standard	ONVIF (PROFILE S, PROFILE G), PSIA, CGI, ISAPI
General Function	One-key Reset , Anti-Flicker, Heartbeat, Mirror, Password Protection, Privacy Mask, Watermark, IP Address Filter
<b>Interface</b>	
Communication Interface	1 RJ45 10M/100M self-adaptive Ethernet port
Audio (-S)	1 audio input (line in), 1 audio output interface
Alarm (-S)	1 alarm input, 1 alarm output
On-board Storage	Built-in microSD/SDHC/SDXC slot, up to 128 GB
<b>Smart Feature-set</b>	
Behavior Analysis	Line crossing detection, intrusion detection, unattended baggage detection, object removal detection
Line Crossing Detection	Cross a pre-defined virtual line, up to 1 pre-defined virtual lines supported
Intrusion Detection	Enter and loiter in a pre-defined virtual region, up to 1 pre-defined virtual regions supported
Object Removal Detection	Objects removed from the pre-defined region, such as the exhibits on display.
Unattended Baggage Detection	Objects left over in the pre-defined region such as the baggage, purse, dangerous materials
Face Detection	Human face appears in the image can be detected and trigger linkage method
<b>General</b>	
Operating Conditions	-30 °C to +60 °C (-22 °F to +140 °F), Humidity 95% or less (non-condensing)
Power Supply	12 VDC ± 25%, 5W PoE(802.3af, class 3), 6.5W
IR Range	Up to 30 m
Protection Level	IP67, IK10
Dimensions	Camera: Φ 111 × 82.4 mm (Φ 4.4" × 3.2") Package: 134 × 134 × 108 mm (5.27" × 5.27" × 4.25")
Weight	Camera: 500 g (1.1 lb.)

## Available Models

DS-2CD2125FHWD-I, DS-2CD2125FHWD-IS

*With -S model: supports 1 audio input, 1 audio output, 1 alarm input, 1 alarm output.*

**Dimensions**

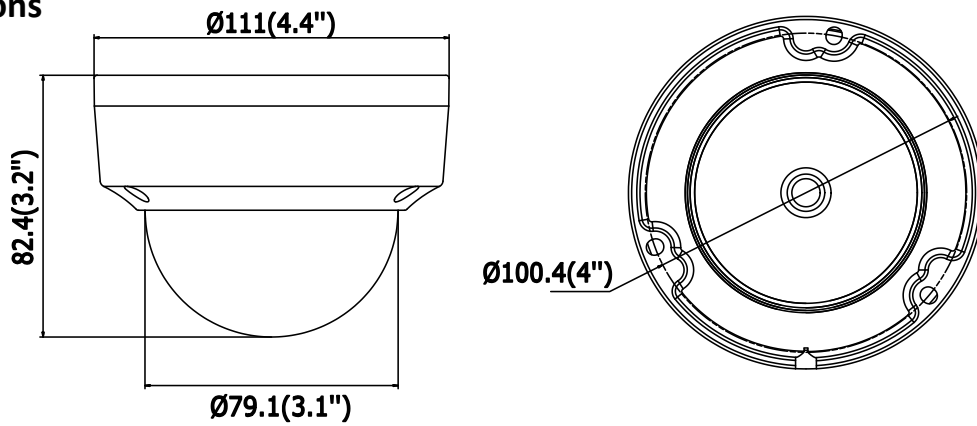

Unit: mm

**Accessories**



Inclined ceiling mount

DS-1259ZJ



Wall mount

DS-1272ZJ-110



Wall mount + Junction Box

DS-1272ZJ-110B



Pendant mount

DS-1271ZJ-110



Junction Box

DS-1280ZJ-DM18



Corner mount

DS-1276ZJ



Vertical Pole mount

DS-1275ZJ



Rain-proof Cap

DS-1250ZJ

Distributed by



**HIKVISION**

**Headquarters**

No.555 Qianmo Road, Binjiang District,  
Hangzhou 310051, China  
T +86-571-8807-5998  
overseasbusiness@hikvision.com

**Hikvision USA**  
T +1-909-895-0400  
sales.usa@hikvision.com

**Hikvision Italy**  
T +39-0438-6902  
info.it@hikvision.com

**Hikvision Singapore**  
T +65-6684-4718  
sg@hikvision.com

**Hikvision Africa**  
T +27 (10) 0351172  
sale.africa@hikvision.com

**Hikvision Europe**  
T +31-23-55-42-770  
info.eu@hikvision.com

**Hikvision France**  
T +33(0)1-85-330-450  
info.fr@hikvision.com

**Hikvision Oceania**  
T +61-2-8599-4233  
salesau@hikvision.com

**Hikvision Hong Kong**  
T +852-2151-1761

**Hikvision Middle East**  
T +971-4-8816086  
salesme@hikvision.com

**Hikvision Spain**  
T +34-91-737-16-55  
info.es@hikvision.com

**Hikvision Canada**  
T +1-909-895-0400  
sales.usa@hikvision.com

**Hikvision Russia**  
T +7-495-669-67-99  
sateru@hikvision.com

**Hikvision Poland**  
T +48-22-460-01-50  
poland@hikvision.com

**Hikvision Korea**  
T +82-31-731-8841  
sales.korea@hikvision.com

**Hikvision India**  
T +91-22-28469900  
sales@pramahikvision.com

**Hikvision UK**  
T +01628-902140  
support.uk@hikvision.com

**Hikvision Brazil**  
T +55 11 3318-0050  
Latam.support@hikvision.com