

DS-2CE72D8T-IT3FS#EU

2MP Ultra Low Light Fixed Turret Camera



- High quality imaging with 2 MP, 1920 × 1080 resolution
- F1.0 aperture
- Clear imaging against strong back light due to 130 dB true WDR technology
- 3D DNR technology delivers clean and sharp images
- 2.8 mm fixed focal lens
- Up to 40 m IR distance for bright night imaging
- High quality audio with audio over coaxial cable, built-in mic
- One port for four switchable signals (TVI/AHD/CVI/CVBS)
- Water and dust resistant (IP67)

▪ Specification

Camera	
Image Sensor	2 MP CMOS
Max. Resolution	1920 (H) × 1080 (V)
Min. Illumination	0.0005 Lux @ (F1.0, AGC ON)
Shutter Time	PAL: 1/25 s to 1/50,000 s; NTSC: 1/30 s to 1/50,000 s
Day & Night	ICR
Angle Adjustment	Pan: 0° to 360°, Tilt: 0° to 75°, Rotation: 0° to 360°
Signal System	PAL/NTSC
Slow Shutter	Max. 16 times
Lens	
Lens Type	2.8 mm fixed focal lens
Focal Length & FOV	2.8 mm, horizontal FOV: 105°, vertical FOV: 56°, diagonal FOV: 123°
Lens Mount	M12
Illuminator	
Supplement Light Type	IR
Supplement Light Range	IR: Up to 40 m
Image	
Image Parameters Switch	STD/HIGH-SAT
Image Settings	Brightness, Contrast, Sharpness, Anti-banding, AGC
Frame Rate	TVI: 1080p @25 fps/30 fps CVI: 1080p @25 fps/30 fps AHD: 1080p @25 fps/30 fps CVBS: PAL/NTSC
Day/Night Mode	Auto
Wide Dynamic Range (WDR)	≥130 dB
Image Enhancement	WDR, BLC, HLC, Global, HLS
Privacy Mask	4 programmable privacy masks
Noise Reduction	3D DNR
White Balance	Auto, Manual
Interface	
Video Output	Switchable TVI/AHD/CVI/CVBS

Built-in Microphone	Yes
Event	
Motion Detection	4 programmable motion areas
General	
Material	Main body: Metal, Enclosure: Plastic
Dimension	Ø109.98 mm × 98.27 mm (Ø4.33" × 3.87")
Weight	Approx. 340 g (0.75 lb.)
Operating Condition	-40 °C to 60 °C (-40 °F to 140 °F). Humidity 90% or less (non-condensing)
Communication	HIKVISION-C
Language	English
Power	12 VDC ± 25%, max. 6.9 W *You are recommended to use one power adapter to supply the power for one camera.
Approval	
Protection	IP67

▪ Available Model



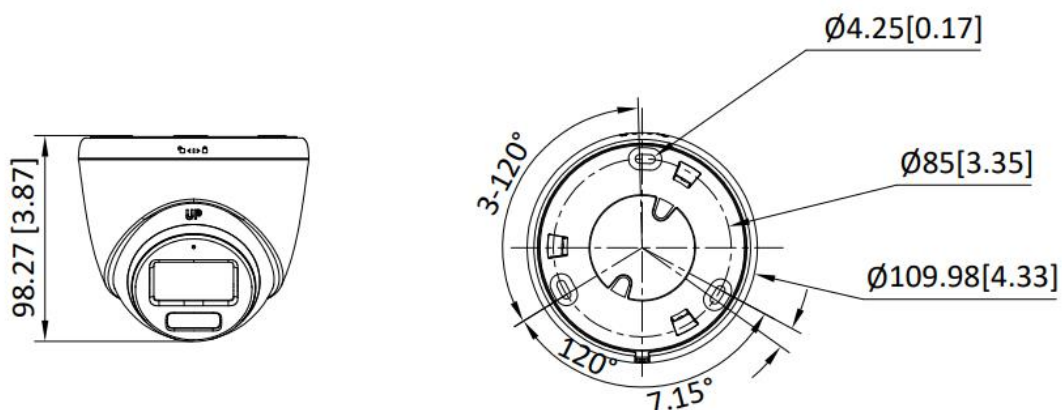

DS-2CE72D8T-IT3FS(2.8mm)(HIK Europe)

▪ Dimension



▪ **Accessory**

▪ **Optional**

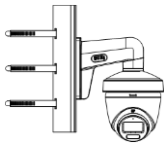
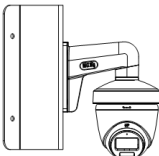
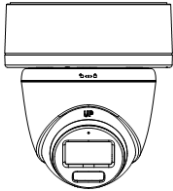
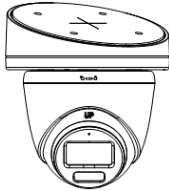
DS-1272ZJ-110-TRS Wall mount	DS-1275ZJ-SUS Vertical pole mount	DS-1276ZJ-SUS Corner mount	DS-1280ZJ-S Junction box	DS-1281ZJ-S Inclined ceiling mount
				
				

Headquarters

No.555 Qianmo Road, Binjiang District,
Hangzhou 310051, China
T +86-571-8807-5998
www.hikvision.com



Follow us on social media to get the latest product and solution information.

