

iDS-2CD7A47G0-XZHS(Y) 4MP ColorVu DeepinView Varifocal Bullet Camera



▪ DeepinView^{series}

- High quality imaging with 4 MP resolution
- Excellent low-light performance via ColorVu technology
- Clear imaging against strong back light due to 140 dB WDR technology
- Efficient H.265+ compression technology to save bandwidth and storage
- 5 streams to meet a wide variety of applications
- Water and dust resistant (IP67) and vandal proof (IK10)

▪ Specification

| Camera | |
|-----------------------------|---|
| Image Sensor | 1/1.8" Progressive Scan CMOS |
| Max. Resolution | 2688 × 1520 |
| Min. Illumination | Color: 0.0003 Lux @ (F1.0, AGC ON), B/W: 0.0001 Lux @ (F1.0, AGC ON), 0 Lux with light |
| Shutter Time | 1 s to 1/100,000 s |
| Day & Night | IR cut filter Blue glass module (less ghost phenomenon) |
| Angle Adjustment | Pan: 0° to 355°, tilt: 0° to 90°, rotate: 0° to 360° |
| Lens | |
| Focal Length & FOV | 2.8 to 12 mm, horizontal FOV 98° to 44.1°, vertical FOV 53.2° to 22.5°, diagonal FOV 115.2° to 50.9° |
| Focus | Auto, Semi-auto, Manual |
| Iris Type | P-iris |
| Aperture | F1.0 to F1.2 |
| DORI | |
| DORI | Wide: D: 60 m, O: 23.8 m, R: 12 m, I: 6 m Tele: D: 149 m, O: 59.1 m, R: 29.8 m, I: 14.9 m |
| Illuminator | |
| Supplement Light Type | Hybrid (IR and White Light) |
| Supplement Light Range | Up to 50 m |
| Smart Supplement Light | Yes |
| IR Wavelength | 850 nm |
| Video | |
| Main Stream | 50 Hz: 50 fps (2688 × 1520, 2560 × 1440, 1920 × 1080, 1280 × 720) 60 Hz: 60 fps (2688 × 1520, 2560 × 1440, 1920 × 1080, 1280 × 720) |
| Sub-Stream | 50 Hz: 25 fps (704 × 576, 640 × 480) 60 Hz: 30 fps (704 × 480, 640 × 480) |
| Third Stream | 50 Hz: 25 fps (1920 × 1080, 1280 × 720, 704 × 576, 640 × 480) 60 Hz: 30 fps (1920 × 1080, 1280 × 720, 704 × 480, 640 × 480) |
| Fourth Stream | 50 Hz: 25 fps (704 × 576, 640 × 480) 60 Hz: 30 fps (704 × 480, 640 × 480) |
| Fifth Stream | 50 Hz: 25 fps (704 × 576, 640 × 480) 60 Hz: 30 fps (704 × 480, 640 × 480) |
| Video Compression | Main stream: H.265+/H.265/H.264+/H.264 Sub-stream: H.265/H.264/MJPEG Third stream: H.265/H.264 Fourth stream: H.265/H.264/MJPEG Fifth stream: H.265/H.264 |
| Video Bit Rate | 32 Kbps to 8 Mbps |
| H.264 Type | Baseline Profile, Main Profile, High Profile |
| H.265 Type | Main Profile |
| Bit Rate Control | CBR, VBR |
| Scalable Video Coding (SVC) | H.264 and H.265 encoding |
| Region of Interest (ROI) | 4 fixed region(s) for each stream |

| | |
|-----------------------------|---|
| Target Cropping | Yes |
| Audio | |
| Audio Type | Mono sound |
| Audio Compression | G.711/G.722.1/G.726/MP2L2/PCM/MP3/AAC-LC |
| Audio Bit Rate | 64 Kbps (G.711ulaw/G.711alaw)/16 Kbps (G.722.1)/16 Kbps (G.726)/32 to 192 Kbps (MP2L2)/8 to 320 Kbps (MP3)/16 to 64 Kbps (AAC-LC) |
| Audio Sampling Rate | 8 kHz/16 kHz/32 kHz/44.1 kHz/48 kHz |
| Environment Noise Filtering | Yes |
| Network | |
| Protocols | TCP/IP, ICMP, HTTP, HTTPS, FTP, SFTP, DHCP, DNS, DDNS, SRTP, RTP, RTSP, RTCP, PPPoE, NTP, UPnP, SMTP, SNMP, IGMP, 802.1X, QoS, IPv4/IPv6, UDP, Bonjour, SSL/TLS, ARP, WebSocket, WebSockets |
| Simultaneous Live View | Up to 20 channels |
| API | Open Network Video Interface (Profile S, Profile G, Profile T), ISAPI, SDK, ISUP |
| User/Host | Up to 32 users 3 user levels: administrator, operator, and user |
| Security | Password protection, complicated password, HTTPS encryption, 802.1X authentication (EAP-TLS, EAP-LEAP, EAP-MD5), watermark, IP address filter, basic and digest authentication for HTTP/HTTPS, WSSE and digest authentication for Open Network Video Interface, RTP/RTSP OVER HTTPS, Control Timeout Settings, Security Audit Log, TLS 1.2, TLS 1.3 |
| Network Storage | NAS (NFS, SMB/CIFS), Auto Network Replenishment (ANR) Together with high-end Hikvision memory card, memory card encryption and health detection are supported. |
| Client | iVMS-4200, Hik-Connect |
| Web Browser | Plug-in required live view: IE 10, IE11 Plug-in free live view: Chrome 57.0+, Firefox 52.0+ |
| Image | |
| Image Parameters Switch | Yes |
| Image Settings | Saturation, brightness, contrast, sharpness, AGC, white balance, adjustable by client software or web browser |
| Day/Night Switch | Day, Night, Auto, Schedule, Alarm Trigger, Video Trigger |
| Wide Dynamic Range (WDR) | 140 dB |
| Image Enhancement | BLC, HLC, 3D DNR, Defog, EIS |
| Privacy Mask | 8 programmable polygon privacy masks |
| Picture Overlay | LOGO picture can be overlaid on video with 128 × 128 24 bit bmp format. |
| Interface | |
| Video Output | 1 Vp-p Composite Output (75 Ω/CVBS) (Only for debugging) |
| Ethernet Interface | 1 RJ45 10 M/100 M/1000 M self-adaptive Ethernet port |
| On-Board Storage | Built-in memory card slot, support microSD/microSDHC/microSDXC card, up to 256 GB |
| Alarm | 2 input(s), 2 output(s) (max. 24 VDC, 1 A) |
| Audio | 1 input (line in), 3.5 mm connector, three-contact, max. input amplitude: 3.3 Vpp, input impedance: 4.7 KΩ, interface type: non-equilibrium 1 output (line out), 3.5 mm connector, three-contact, max. output amplitude: 3.3 Vpp, output impedance: 100 Ω, interface type: non-equilibrium, mono sound |
| RS-485 | 1 RS-485 (Half duplex, HIKVISION, Pelco-P, Pelco-D, self-adaptive) |

| | |
|----------------------------------|---|
| Reset Key | Yes |
| Power Output | 12 VDC, max. 100 mA |
| Event | |
| Basic Event | Motion detection, video tampering alarm, network disconnected, IP address conflict, illegal login, HDD full, HDD error, video quality diagnosis, vibration detection, abnormal reboot |
| Smart Event | Line crossing detection, intrusion detection, region entrance detection, region exiting detection (support alarm triggered by specified target types (human and vehicle)), scene change detection, audio exception detection, defocus detection |
| Linkage | Upload to FTP/NAS/memory card, notify surveillance center, send email, trigger alarm output, trigger recording, trigger capture, white light flashing, audible warning |
| Deep Learning Function | |
| Multi-target-type Detection | <p>Detects up to 60 targets simultaneously</p> <p>Supports simultaneous detection and capture of human body, face and vehicle</p> <p>Gets 7 face features</p> <p>Gets 13 human body features</p> <p>Gets 2 vehicle features</p> |
| Face Capture | <p>Detects up to 120 faces simultaneously</p> <p>Supports swing left and right from -60° to 60°, tilt up and down from -30° to 30°</p> <p>Uploads face with background and closed-up face pictures</p> |
| Face Comparison | <p>Up to 10 face libraries. 30,000 faces for each library. 150,000 faces in total.</p> <p>Recognizes face identity via face modeling, grading and comparing to those in face library</p> <p>Supports face library encryption</p> |
| Heat Map | <p>A graphic description of visits (by calculating amount of people or amount of dwell time) in a configured area.</p> <p>Two report types are available, space heat map and time heat map line chart.</p> |
| Queue Management | <p>Detects queuing-up people number, and waiting time of each person</p> <p>Generates reports to compare the efficiency of different queuing-ups and display the changing status of one queue</p> <p>Supports raw data export for further analysis.</p> |
| General | |
| Power | <p>Three-core terminal block</p> <p>12 VDC ± 20%, 1.90 A, max. 22.7 W</p> <p>24 VAC ± 20%, 1.39 A, max. 22.3 W</p> <p>PoE: 802.3at, Type 2, Class 4, 42.5 V to 57 V, 0.59 A to 0.44 A, max. 24.7 W</p> |
| Material | Aluminum alloy body |
| Dimension | Ø140 mm × 378.4 mm (Ø5.5" × 14.9") |
| Package Dimension | 425 mm × 190 mm × 180 mm (16.7" × 7.5" × 7.1") |
| Weight | Approx. 2280 g (5.0 lb.) |
| With Package Weight | Approx. 3370 g (7.4 lb.) |
| Storage Conditions | -40 °C to 60 °C (-40 °F to 140 °F). Humidity 95% or less (non-condensing) |
| Startup and Operating Conditions | -40 °C to 60 °C (-40 °F to 140 °F). Humidity 95% or less (non-condensing) |

| | |
|---------------------------|---|
| Language | 33 languages: English, Russian, Estonian, Bulgarian, Hungarian, Greek, German, Italian, Czech, Slovak, French, Polish, Dutch, Portuguese, Spanish, Romanian, Danish, Swedish, Norwegian, Finnish, Croatian, Slovenian, Serbian, Turkish, Korean, Traditional Chinese, Thai, Vietnamese, Japanese, Latvian, Lithuanian, Portuguese (Brazil), Ukrainian |
| General Function | Heartbeat, anti-banding, one-key reset, mirror, password protection, privacy mask, watermark, IP address filter, flash log, control timeout |
| Heater | Yes |
| Demist | Yes |
| Approval | |
| EMC | FCC: 47 CFR Part 15, Subpart B CE-EMC: EN 55032: 2015, EN 61000-3-2: 2019, EN 61000-3-3: 2013 + A1: 2019, EN 50130-4: 2011 + A1: 2014 RCM: AS/NZS CISPR 32: 2015 IC: ICES-003: Issue 7 KC: KN32: 2015, KN35: 2015 |
| Safety | UL: UL 62368-1 CB: IEC 62368-1: 2014 + A11 CE-LVD: EN 62368-1: 2014/A11: 2017 BIS: IS 13252 (Part 1): 2010/IEC 60950-1: 2005 LOA: IEC/EN 60950-1 |
| Environment | CE-RoHS: 2011/65/EU WEEE: 2012/19/EU Reach: Regulation (EC) No 1907/2006 |
| Protection | IP67: IEC 60529-2013, IK10: IEC 62262: 2002 |
| Anti-Corrosion Protection | -Y model: NEMA 4X (NEMA 250-2018) |
| Automotive and Railway | EN50121-4 |
| Other | PVC FREE |

▪ Function

Face Recognition

With embedded deep learning based algorithms, the camera is able to give the best shot of a target face through detecting, tracking, capturing, grading and selecting. The camera captures the face and outputs the features, such as gender, age, and expression. The camera uses face exposure function to dynamically adjust face area exposure of captures and ensures high face picture quality.

Perimeter Protection

With embedded deep learning based target detection and classification algorithms, the camera carries out the duty of perimeter protection, monitoring the actions of line crossing, intrusion, region entrance, and region exiting. The algorithms greatly filter out the mistaken alarm caused by the interference of leaves, lights, animal, flag, etc.

Multi-Target-Type Recognition

With the embedded deep learning algorithms, the camera detects and captures the face, human body, vehicle in the specified region and outputs the features, such as gender, age, top color, and vehicle type.

▪ Typical Application

Hikvision products are classified into three levels according to their anti-corrosion performance. Refer to the following description to choose for your using environment.

With -Y model: This model has MODERATE PROTECTION.

Without -Y model: This model has NO SPECIFIC PROTECTION.

| Level | Description |
|------------------------|--|
| Top-level protection | Hikvision products at this level are equipped for use in areas where professional anti-corrosion protection is a must. Typical application scenarios include coastlines, docks, chemical plants, and more. |
| Moderate protection | Hikvision products at this level are equipped for use in areas with moderate anti-corrosion demands. Typical application scenarios include coastal areas about 2 kilometers (1.24 miles) away from coastlines, as well as areas affected by acid rain. |
| No specific protection | Hikvision products at this level are equipped for use in areas where no specific anti-corrosion protection is needed. |

▪ **Available Model**

iDS-2CD7A47G0-XZH5Y (2.8 to 12 mm)



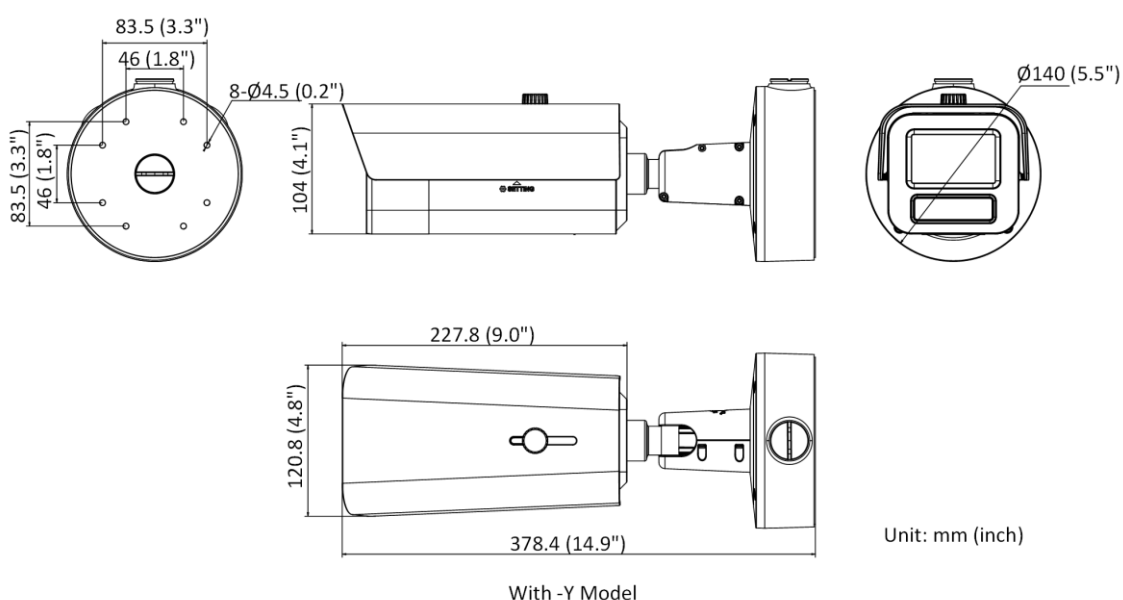

iDS-2CD7A47G0-XZH5 (2.8 to 12 mm)

▪ **Dimension**



▪ **Accessory**

▪ **Optional**

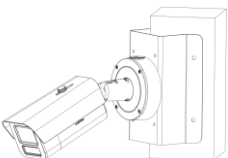
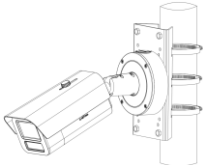
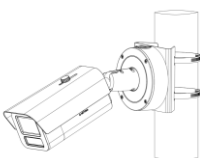
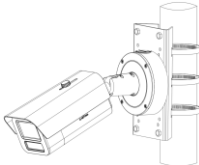
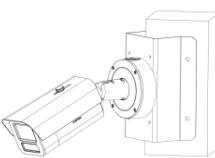
| DS-1476ZJ-SUS Corner Mount | DS-1475ZJ-Y Vertical Pole Mount | DS-1275ZJ-S-SUS Vertical Pole Mount | DS-1475ZJ-SUS Vertical Pole Mount | DS-1476ZJ-Y Corner Mount |
|---|---|---|---|---|
|  |  |  |  |  |
|  |  |  |  |  |

Headquarters

No.555 Qianmo Road, Binjiang District,
Hangzhou 310051, China
T +86-571-8807-5998
www.hikvision.com



Follow us on social media to get the latest product and solution information.

