

Partition keypad **INT-SK**

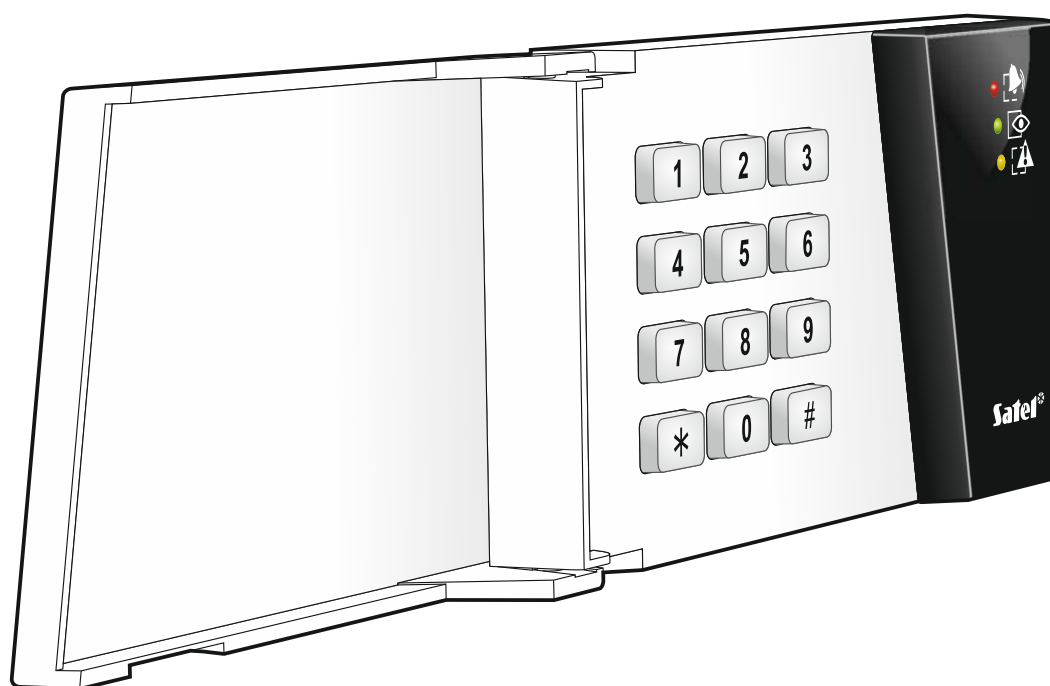

Firmware version 2.00

WARNINGS

The device should be installed by qualified personnel.

Read carefully this manual before proceeding to installation.

Changes, modifications or repairs not authorized by the manufacturer shall void your rights under the warranty.

The SATEL's goal is to continually upgrade the quality of its products, which may result in alterations of their technical specifications and firmware. The current information on the introduced modifications is available on our website.

Please visit us:
<http://www.satel.eu>

The declaration of conformity may be consulted at www.satel.eu/ce

The following symbols may be used in this manual:



- note;



- caution.

The INT-SK partition keypad offers control of one partition in the alarm system and provides access control features. The device can be used in conjunction with the INTEGRA and INTEGRA Plus control panels.

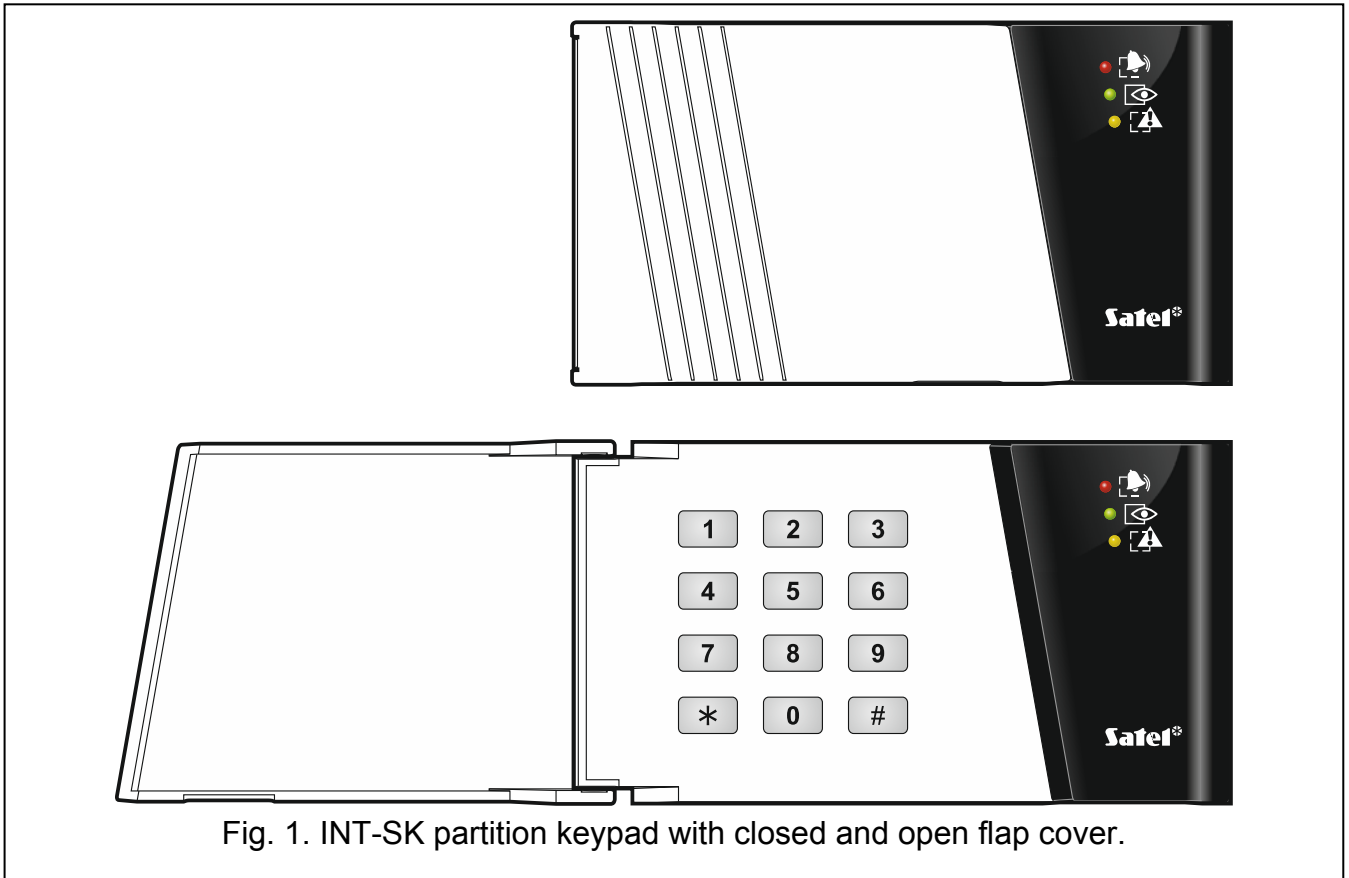

Fig. 1. INT-SK partition keypad with closed and open flap cover.

1. Features

- Arming / disarming and alarm clearing in partition.
- Capability of triggering alarm from the keypad.
- Access control functions:
 - single door control,
 - relay output for control of electric strike, electromagnetic lock or another door actuator,
 - dedicated input for connecting a door opening sensor.
- Control of 24. MONO SWITCH and 25. BI SWITCH type outputs.
- The ability to change access code by the user.
- LEDs indicating the partition status.
- 12 keys with backlighting.
- Built-in sounder.
- Tamper contact reacting to the enclosure opening or removing from the wall.

2. Installation



Disconnect power before making any electrical connections.

The keypad is designed for indoor installation. The place of installation should be readily accessible to the system users.

1. Open the keypad enclosure.
2. Set the partition keypad address (see “Setting address”).
3. Place the enclosure base on the wall and mark the location of mounting holes.
4. Drill the holes for wall plugs (screw anchors).
5. Run the wires through the opening in the enclosure base.
6. Using wall plugs (screw anchors) and screws, fasten the enclosure base to the wall.
7. Connect the CLK, DTA and COM terminals to the appropriate terminals of the control panel expander bus (see the control panel installer manual). It is recommended that an unshielded non-twisted cable be used for making the connection. If you use the twisted-pair type of cable, remember that CLK (clock) and DTA (data) signals must not be sent through one twisted-pair cable. The wires must be run in one cable.
8. If the partition keypad is to control an electric strike, electromagnetic lock or another door actuator, connect corresponding wires to the NO terminals (see Fig. 2). It is not recommended that the door actuator be powered from the same source as the partition keypad.

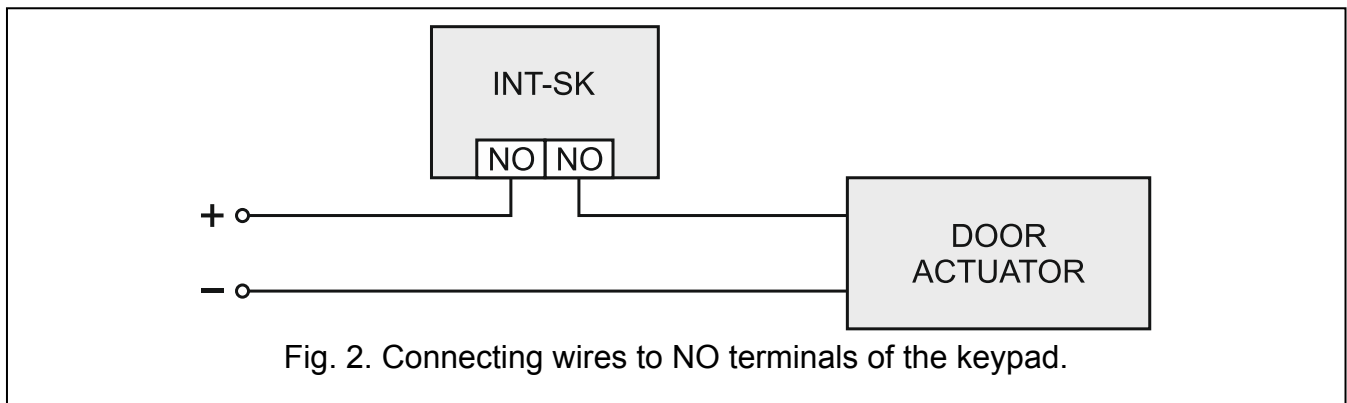

9. Connect the wires of door status sensor to the IN and COM terminals. If the door status is not to be monitored, connect the IN terminal to the keypad COM terminal or, when configuring the keypad, set value 0 for the MAX. DOOR OPEN TIME parameter.
10. Connect the power wires to the +12V and COM terminals. The keypad may be powered directly from the control panel, from an expander with power supply or from a power supply unit.
11. Close the keypad enclosure.
12. Power on the alarm system.
13. Start the identification function in the control panel (see the control panel installer manual). The keypad will be identified as “INT-S/SK”.

2.1 Setting address

To set address, use the switches 1-5 of the DIP-switch package. A numerical value is assigned to each switch. In OFF position, the value is 0. Numerical values assigned to individual switches in ON position are shown in Table 1. The sum of numerical values assigned to switches 1-5 means the address set on the module. The address must be different from that on the other modules connected to the communication bus of the control panel.

DIP-switch number	1	2	3	4	5
Numerical value	1	2	4	8	16

Table 1.

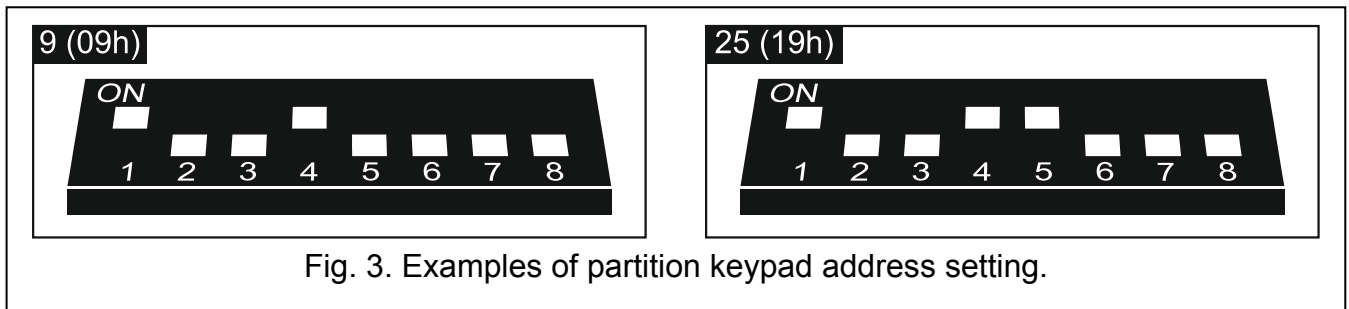

Fig. 3. Examples of partition keypad address setting.

2.2 Description of terminals

- NO** - relay output
IN - door status monitoring input (NC)
COM - common ground
+12V - power input
DTA - data (expander communication bus)
CLK - clock (expander communication bus)

3. Configuration

Parameters and options of the partition keypad can be configured using:

- LCD keypad: ►SERVICE MODE ►STRUCTURE ►HARDWARE ►EXPANDERS ►SETTINGS ►[name of partition keypad],
- DLOADX program: →“Structure” window →“Hardware” tab →“Expansion modules” branch →[name of partition keypad].

3.1 Description of parameters and options

Shown in square brackets are the names of parameters and options as they are presented on the LCD keypad display.

Name – individual name of the device (up to 16 characters).

Partition – partition operated by the keypad.

Lock [Lock feature] – if this option is enabled, the partition keypad supports the access control functions (you can program the following parameters: LOCK FEATURES, RELAY ON TIME, RELAY, MAX. DOOR OPEN TIME etc.).

Lock features [Lock function] – relay operating mode:

ON if partition armed [On if part.armed] – relay is active when the partition is armed, and inactive when the partition is disarmed.



*If the partition is disarmed in a different way than by means of the partition keypad, the relay will only be deactivated after entering the code and pressing *****.*

Fixed ON time [ON time] – after entering the code and pressing *****, the relay will be active for the duration of RELAY ON TIME.

Fixed ON time – OFF if door open [ON, open→off] – after entering the code and pressing *****, the relay will be active until the door is opened (the door status monitoring input disconnected from common ground), but not longer than for the duration of RELAY ON TIME.

Fixed ON time – OFF if door closed [ON, close→off] – after entering the code and pressing *, the relay will be active until the door is closed (the door status monitoring input reconnected to common ground), but not longer than for the duration of RELAY ON TIME.

Relay ON time – the time period during which the relay can be active. You can enter from 1 to 255 seconds.

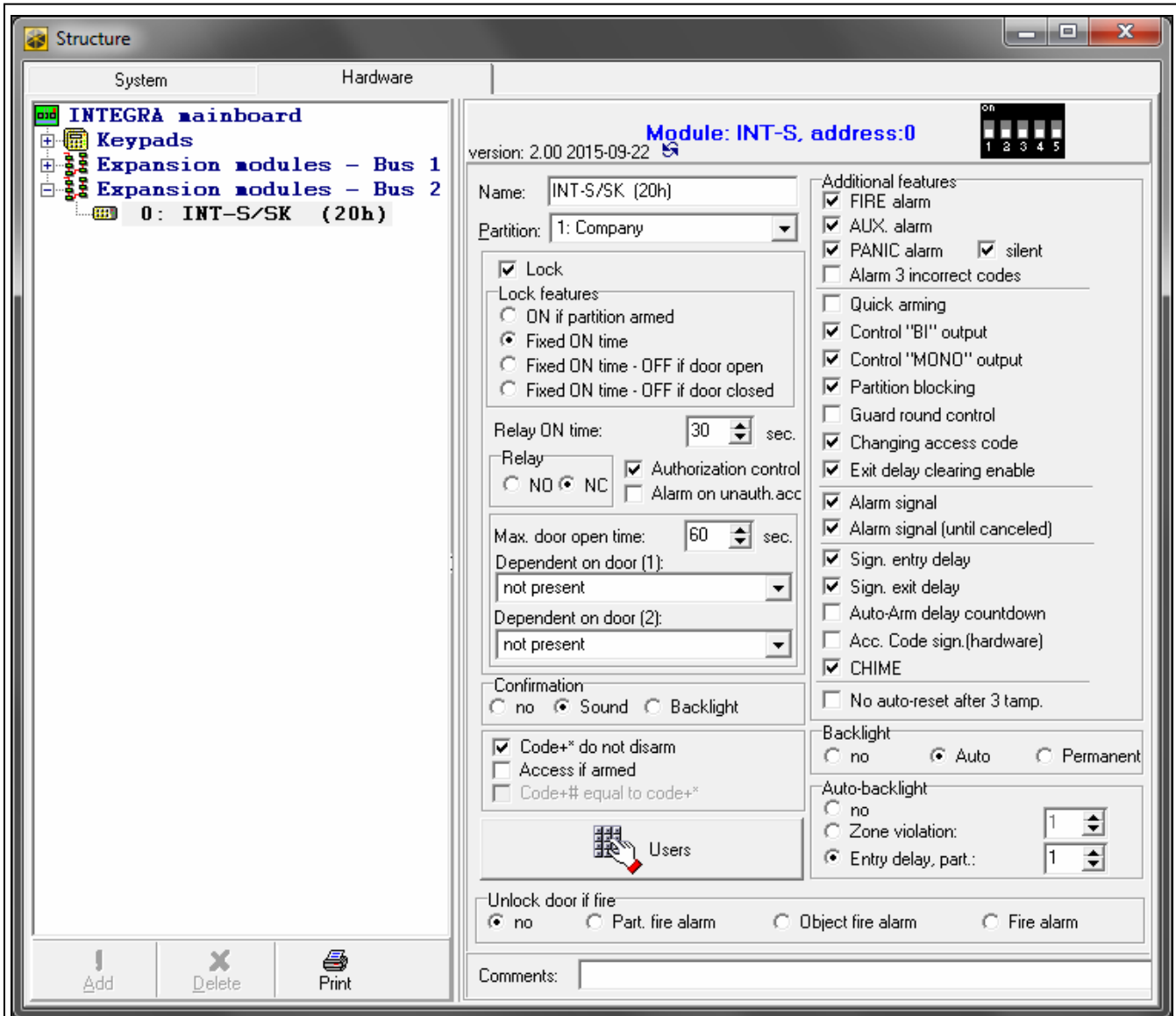

Fig. 4. DLOADX program: parameters and options of partition keypad.

Relay [Relay type] – status of the deactivated relay:

NO [Normal.open NO] – the relay contacts are open (they close on activating the relay).

NC [Normal.closed NC] – the relay contacts are closed (they open on activating the relay).

Authorization control [Unauth. event] – if this option is enabled, unauthorized opening of the door will save the event to the control panel memory.

Alarm on unauth. access [Unauth. alarm] – if this option is enabled, unauthorized opening of the door when the partition is armed will trigger an alarm. The option is available if the AUTHORIZATION CONTROL option is enabled.

Max. door open time – the maximum period of time during which the door can be open (the door status monitoring input can be disconnected from common ground). If the door is open longer, audible alarm will be triggered in the partition keypad, and the event will be

saved to the control panel memory. You can enter from the 0 to 255 seconds. If value 0 is programmed, the door status will not be monitored.

Dependent on door (1) / Dependent on door (2) – you may define the door that must be closed to be able to unlock the door controlled by the partition keypad (to activate the relay). You may define a door supervised by another expander or alarm system zone programmed as type 57 TECHNICAL – DOOR OPEN.

Confirmation – you can select whether and how the partition keypad is to communicate with the user during operation:

No – the partition keypad will not inform the user in any way about execution of or refusal to execute an operation.

Sound – the partition keypad will inform the user audibly about execution of or refusal to execute an operation.

Backlight – the partition keypad will inform the user by blinking key backlight about execution of or refusal to execute an operation.

Code+* do not disarm [Code* not dis.] – if this option is enabled, entering the code and pressing will not disarm the partition.

Access if armed [Code* in arm] – if this option is enabled, entering the code and pressing will unlock the door controlled by the module even if the partition is armed. The option is available, if the CODE+* DO NOT DISARM option is enabled.

Users [Master users / Users] – define the master users (administrators) and users authorized to use the device.

FIRE alarm – if this option is enabled, pressing and holding for 3 seconds will trigger the fire alarm.

AUX. alarm [Medical alarm] – if this option is enabled, pressing and holding for 3 seconds will trigger the medical alarm.

PANIC alarm – if this option is enabled, pressing and holding for 3 seconds will trigger the panic alarm.

silent [Silent panic] – if this option is enabled, the panic alarm triggered from the keypad will be a silent alarm (without audible alarm signal). This option is available, if the PANIC ALARM option is enabled.

Alarm 3 incorrect codes [3 wrong codes] – if this option is enabled, entering a wrong code three times will trigger an alarm.

Quick arming – if this option is enabled, arming from the keypad is possible without entering the code.

Control “BI” output [BI outs ctrl.] – if this option is enabled, the partition keypad accepts the “BI” OUTPUT OPERATING type of codes.

Control “MONO” output [MONO outs ctr.] – if this option is enabled, the partition keypad accepts the “MONO” OUTPUT OPERATING type of codes.

Partition blocking [Part.blocking] – if this option is enabled, entering the BLOCKING PARTITION or GUARD type of code will temporarily block the partition when armed (violating a zone belonging to the partition will not trigger any alarm). The time of blocking should be defined for the partition or the code (of the BLOCKING PARTITION type).

Guard round control [Guard control] – if this option is enabled, entering the GUARD type of code will be recorded as completion of a guard round.

Changing access code [Changing code] – if this option is enabled, the user can change own code from the partition keypad.

Exit delay clearing enable [Fin.exit time] – if this option is enabled, the partition exit delay time will be reduced on pressing in turn the **9** and **#** keys (if the EXIT DELAY CLEARING option is enabled for the partition).

Alarm signal [Alarm (time)] – if this option is enabled, the keypad will audibly signal alarms throughout the GLOBAL ALARM TIME.

Alarm signal (until canceled) [Alarm (latch)] – if this option is enabled, the partition keypad will audibly signal alarms until they are cleared.

Sign. entry delay [Entry time] – if this option is enabled, the partition keypad will audibly signal the entry delay countdown.

Sign. exit delay [Exit time] – if this option is enabled, the partition keypad will audibly signal the exit delay countdown.

Auto-Arm delay countdown [Auto-arm delay] – if this option is enabled, the partition keypad will audibly signal the auto-arm delay countdown.

Acc. code sign. (hardware) [Code entered] – if this option is enabled, the partition keypad will confirm with a single beep that the code has been entered. This signal is useful where a time lag occurs between entering the code and generating the audible signal after verification of the code by the control panel.

CHIME [Chime zones] – if this option is enabled, the partition keypad will audibly signal violation of zones with CHIME IN MODULE option enabled, belonging to the partition operated by means of the keypad.

No auto-reset after 3 tamp. [No autorst.3t.] – if this option is enabled, the feature reducing the number of tamper alarms from the module to three is disabled (the feature prevents multiple logging of the same events and applies to successive uncleared alarms).

Backlight – you can define how the keypad backlight will operate:

No – the keypad backlight will be permanently off.

Auto – the keypad backlight will go on after any key is pressed. Additionally, it can be turned on if a specific event occurs (see the AUTO-BACKLIGHT parameter). The keypad backlight goes on for about 40 seconds from pressing the key / occurrence of the event.

Permanent – the keypad backlight will be permanently on.

Auto-backlight – if the keypad backlight comes on automatically, you can additionally define whether and what event will turn the backlight on:

No – the keypad backlight will only go on after pressing any key.

Zone violation – the keypad backlight will additionally go on if a selected zone is violated.

Entry delay, part. – the keypad backlight will additionally go on if entry delay countdown starts in the selected partition.

Unlock door if fire [Doors on fire] – you can define whether and when the fire alarm will unlock the door controlled by the partition keypad (i.e. will activate the relay):

No [no open] – the door will not be unlocked in the event of fire alarm.



Part. fire alarm [on partit. fire] – the door will be unlocked in the event of fire alarm in the partition to which the keypad is assigned.

Object fire alarm [on object fire] – the door will be unlocked in the event of fire alarm in the object to which the keypad is assigned.

Fire alarm [on any fire] – the door will be unlocked in the event of fire alarm in the alarm system.



4. Operation

4.1 Description of LED indicators

LED	Color	Description of indications
	red	ON or blinking – alarm or alarm memory
	green	ON – partition is armed blinking – exit delay countdown is running
	yellow	blinking – trouble or trouble memory (the LED goes out when the partition is armed)



Information about the armed state can be extinguished after a preset time.

The  and  LEDs blinking alternately indicate waiting for the second code to be entered during two-code arming / disarming.

All LEDs blinking in turn indicate that there is no communication with the control panel.

4.2 Description of audible signaling

4.2.1 Beeps generated when operating



Audible signaling can be disabled or replaced with blinking of the keypad backlight (see section "Configuration").

1 short beep – pressing of any number key or confirmation that code has been entered.

2 short beeps – acceptance of the first code during two code arming / disarming.

3 short beeps – signaling of:

- starting the procedure of arming (there is exit delay in the partition) or arming (there is no exit delay in the partition),
- disarming and/or alarm clearing.

4 short and 1 long beeps – confirmation of function execution.

3 pairs of short beeps – the user should change his/her code.

1 long beep – refusal to arm (there are violated zones in the partition or there is a trouble).

2 long beeps – unknown code.

3 long beeps – unavailable function.

4.2.2 Signaling events



You can define which events will be audibly signaled (see section "Configuration").

5 short beeps – zone violation (CHIME).

Long beep every 3 seconds, followed by a series of short beeps for 10 seconds and 1 long beep – countdown of exit delay (if the time is shorter than 10 seconds, only the final sequence of short beeps will be generated).

A sequence of 7 beeps of diminishing duration, repeated every few seconds – countdown of auto-arming delay.

2 short beeps every second – countdown of entry delay.

Continuous beep – alarm.

Long beep every 2 seconds – alarm memory.

Long beep every second – fire alarm.

Short beep every 2 seconds – fire alarm memory.

Very short beeps – door open too long.

4.3 Code

Operating the alarm system from the keypad is possible after entering the code using the number keys (authorization by means of the code). Only some functions can be run without the code being entered. By factory default, the following codes are programmed in the control panel:

service code: 12345

object 1 master user (administrator) code: 1111



The factory default codes should be changed before you start using your alarm system

Do not make your code available to other people.

4.4 Available functions

4.4.1 [Code] *

Depending on the type and rights of the user, partition keypad settings and alarm system status, entering the code and pressing will execute one or a few of the following functions:

- unlocking the door (activating the relay),
- disarming the partition,
- clearing alarm,
- toggling the status of 25. BI SWITCH type outputs,
- activating the 24. MONO SWITCH type outputs,
- confirming guard round,
- temporarily blocking the partition.

Most of the above mentioned functions are available after enabling the LOCK [LOCK FEATURE] option for the partition keypad. Availability of individual functions depends also on other settings of the partition keypad (e.g. when the lock is executing the ON IF PARTITION ARMED [ON IF PART.ARMED] function, most functions are not available).

4.4.2 [Code]

Depending on the type and rights of the user, partition keypad settings and alarm system status, entering the code and pressing will execute one or a few of the following functions:

- starting the partition arming procedure / arming,
- disarming the partition,
- clearing alarm,
- toggling the status of 25. BI SWITCH type outputs,
- activating the 24. MONO SWITCH type outputs,
- confirming guard round,
- temporarily blocking the partition.

- unblocking cash machine access.

4.4.3 Quick arming



Arming without entering the code is possible, if the QUICK ARMING option is enabled.

1. Select the arming mode (press one of the keys: **0** – full arming; **1** – full arming + bypasses; **2** – arming without interior; **3** – arming without interior and without entry delay).
2. Press **#** to start the arming procedure.

4.4.4 Triggering the alarm from keypad



Triggering the alarm from the keypad is possible, if respective options are enabled in the partition keypad settings.

Fire alarm – press and hold the ***** key for about 3 seconds.

Medical (auxiliary) alarm – press and hold the **0** key for about 3 seconds.

Panic alarm – press and hold the **#** key for about 3 seconds. It depends on the partition keypad settings whether the loud panic alarm (with loud alarm signal) or the silent panic alarm (without loud alarm signal) will be triggered.

4.4.5 Silencing alarm at the partition keypad

Press any number key. The signaling will be silenced for about 40 seconds.

4.4.6 Code changing



The user can change their code, if the CHANGING ACCESS CODE [CHANGING CODE] option is enabled.

1. Press and hold the **1** key for about 3 seconds.
2. When the and LEDs start blinking alternately, enter the old code and press **#**.
3. When the and LEDs start blinking alternately, enter the new code and press **#**.

4.5 Partition keypad operation and EN 50131 requirements

If the control panel has been configured in accordance with the requirements of Standard EN 50131 for Grade 2 (INTEGRA) or Grade 3 (INTEGRA Plus):

- the keypad does not signal alarms,
- the LED indicates alarms only after user authorization (i.e. after entering the code),
- blinking of the LED indicates a trouble, bypassed zones or an alarm,
- the LED goes out after 60 seconds (Grade 3),
- quick arming functions are not available,
- arming procedure cannot be initiated, if there are violated zones in the partition or there is a trouble in the system,
- the partition will not be armed if, at the moment of completion of exit delay countdown:
 - there is a violated zone in partition which was not violated when the arming procedure was started,
 - there is a trouble which did not exist when the arming procedure was started.

5. Specifications

Supply voltage	12 V DC \pm 15%
Standby current consumption	35 mA
Maximum current consumption	55 mA
Relay output rating (resistive load).....	2 A / 24 V DC
Environmental class according to EN50130-5	II
Operating temperature range.....	-10 °C...+55 °C
Maximum humidity	93 \pm 3%
Dimensions	144 x 80 x 27 mm
Weight.....	160 g